

## BWCM Series



Due to accurate wire winding technology, these chip inductors are designed for filtering impedance matching, resonance and choke circuits for RF designer. Both standard series and custom designs are available.

### Features

- RoHS Compliant
- Ceramic body and wire wound construction provide high SRFs
- Exceptional Q value even at high frequencies
- Ceramic construction delivers the highest possible SRFs as well as high Q value
- Low DC resistance design supports low loss, high output and low power consumption
- CM series is standard for RF designers

### Applications

- RF products for cellular phone
- GPS receiver
- Base Station
- Repeater
- Wireless LAN/ mouse/ keyboard/ earphone
- Remote control
- Security system and other RF modules

### Product Identification

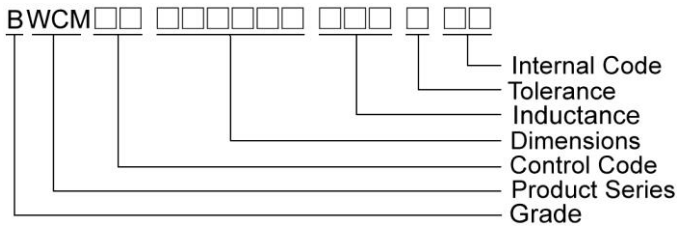

### Shape and Dimensions / Recommended Pattern

**BWCM00060404**

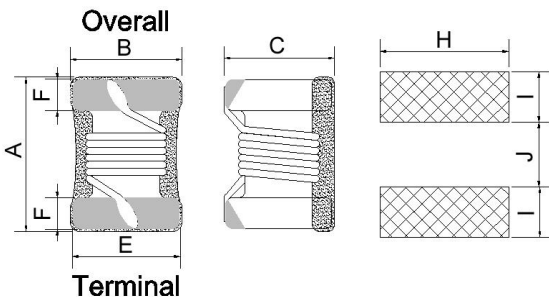

**BWCM00110705/181010**

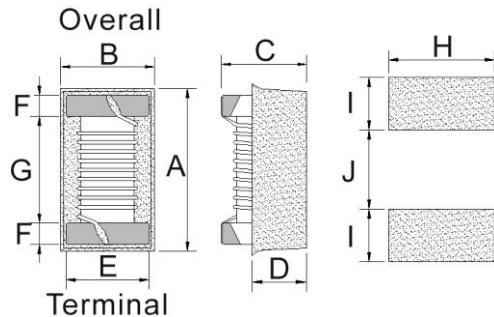

### Dimensions

	A	B	C	D	E	F	G	H	I	J
<b>BWCM00060404</b>	0.53±0.05	0.40±0.05	0.40±0.05	-	0.38	0.10	-	0.40	0.21	0.23
<b>BWCM00110705</b>	1.1±0.1	0.70±0.1	0.5±0.1	0.35	0.60	0.15	0.70	0.66	0.40	0.60
<b>BWCM00181010</b>	1.80±0.1	1.00±0.1	0.95±0.1	0.60	0.90	0.23	1.15	1.15	0.57	0.86

# SMD Wire Wound Ceramic Chip Inductors - BWCM Series

## Shape and Dimensions / Recommended Pattern

**BWCM00120707**

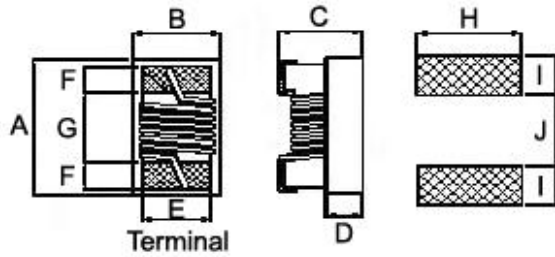

**BWCM00161008**

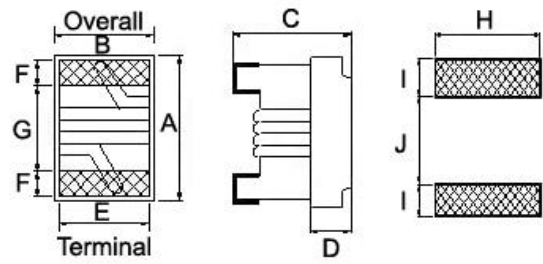

Dimensions

	A	B	C	D	E	F	G	H	I	J
<b>BWCM00120707</b>	1.19 Max	0.70 Max	0.66 Max	0.25	0.51	0.23	0.56	0.66	0.36	0.46
<b>BWCM00161008</b>	1.6 <sup>+0.2</sup> <sub>-0.1</sub>	1.02±0.1	0.82 <sup>+0.2</sup> <sub>-0.1</sub>	0.35	0.70	0.30	0.95	1.02	0.64	0.64

# SMD Wire Wound Ceramic Chip Inductors - BWCM Series

## Electrical Characteristics

Part Number	Inductance (nH)	Tolerance (±%)	Test Frequency (MHz)	Q Typ.	Test Frequency (MHz)	SRF (GHz) Min	RDC (Ω) Max	Irms (mA) Typ.
BWCM000604041N0□00	1.0	±0.2nH	250	48	900	19	0.03	900
BWCM000604041N1□00	1.1	±0.2nH	250	41	900	19	0.06	660
BWCM000604041N7□00	1.7	±0.2nH	250	41	900	19	0.07	600
BWCM000604041N8□00	1.8	±0.2nH	250	37	900	19	0.10	520
BWCM000604041N9□00	1.9	±0.2nH	250	41	900	19	0.08	620
BWCM000604042N0□00	2.0	±0.2nH	250	42	900	19	0.10	490
BWCM000604042N1□00	2.1	±0.2nH	250	35	900	19	0.16	400
BWCM000604042N2□00	2.2	±0.2nH	250	33	900	19	0.16	400
BWCM000604042N7□00	2.7	±0.2nH	250	46	900	15	0.06	720
BWCM000604042N8□00	2.8	±0.2nH	250	44	900	14	0.08	600
BWCM000604042N9□00	2.9	±0.2nH	250	41	900	13	0.10	540
BWCM000604043N0□00	3.0	±0.2nH	250	34	900	14	0.22	350
BWCM000604043N1□00	3.1	±0.2nH	250	48	900	12	0.07	720
BWCM000604043N2□00	3.2	±0.2nH	250	48	900	10	0.08	580
BWCM000604043N3□00	3.3	±0.2nH	250	47	900	11	0.11	520
BWCM000604043N4□00	3.4	±0.2nH	250	43	900	11	0.15	440
BWCM000604043N5□00	3.5	±0.2nH	250	43	900	12	0.15	440
BWCM000604043N6□00	3.6	±0.2nH	250	36	900	11	0.23	340
BWCM000604043N7□00	3.7	±0.2nH	250	38	900	11	0.23	340
BWCM000604043N9□00	3.9	±0.2nH	250	48	900	11	0.07	650
BWCM000604044N3□00	4.3	5	100	45	900	11	0.12	480
BWCM000604044N7□00	4.7	5	100	45	900	9.5	0.09	620
BWCM000604045N1□00	5.1	5	100	45	900	9.5	0.14	480
BWCM000604045N4□00	5.4	5	100	46	900	9.5	0.21	420
BWCM000604045N6□00	5.6	5	100	37	900	8.3	0.33	330
BWCM000604045N8□00	5.8	5	100	47	900	8.8	0.16	460
BWCM000604046N2□00	6.2	5	100	39	900	9.9	0.22	360
BWCM000604046N8□00	6.8	5	100	42	900	7.7	0.18	460
BWCM000604047N5□00	7.5	5	100	41	900	7.5	0.24	400
BWCM000604048N2□00	8.2	5	100	40	900	8.5	0.26	290

**Note: When ordering, please specify tolerance code. Tolerance : C=±0.2nH , J=±5%**

- Operating temperature range - 55°C ~ 125°C(Including self - temperature rise)
- Irms for a 20°C temperature rise from 25°C ambient with current
- Offset value : -0.48nH
- Measure Equipment :  
 L & Q : HP4286A/HP4287A/AgilentE4991/Keysight E4982A  
 SRF : Agilent HP8753D/ AgilentE4991  
 RDC : HP4287A/Keysight E4982A  
 Irms : HP4284A+HP42841A/HP4285A+HP42841A

# SMD Wire Wound Ceramic Chip Inductors - BWCM Series

Part Number	Inductance (nH)	Tolerance (±%)	Test Frequency (MHz)	Q Typ.	Test Frequency (MHz)	SRF (GHz) Min	RDC (Ω) Max	Irms (mA) Typ.
BWCM000604048N7□00	8.7	5	100	39	900	7.5	0.42	290
BWCM000604049N1□00	9.1	5	100	46	900	6.4	0.22	460
BWCM0006040410N□00	10	5	100	37	900	7.2	0.46	250
BWCM0006040411N□00	11	5	100	37	900	7.0	0.47	260
BWCM0006040412N□00	12.5	5	100	39	900	6.0	0.54	280
BWCM0006040413N□00	13	5	100	39	900	5.9	0.54	280
BWCM0006040414N□00	13.5	5	100	37	900	6.0	0.53	240
BWCM0006040415N□00	15.5	5	100	38	900	5.7	0.60	230

**Note: When ordering, please specify tolerance code. Tolerance : C=±0.2nH , J=±5%**

- Operating temperature range - 55°C ~ 125°C(Including self - temperature rise)
- Irms for a 20°C temperature rise from 25°C ambient with current
- Offset value : -0.48nH
- Measure Equipment :  
 L & Q : HP4286A/HP4287A/AgilentE4991/Keysight E4982A  
 SRF : Agilent HP8753D/ AgilentE4991  
 RDC : HP4287A/Keysight E4982A  
 Irms : HP4284A+HP42841A/HP4285A+HP42841A

Typical **L** vs. **Frequency**

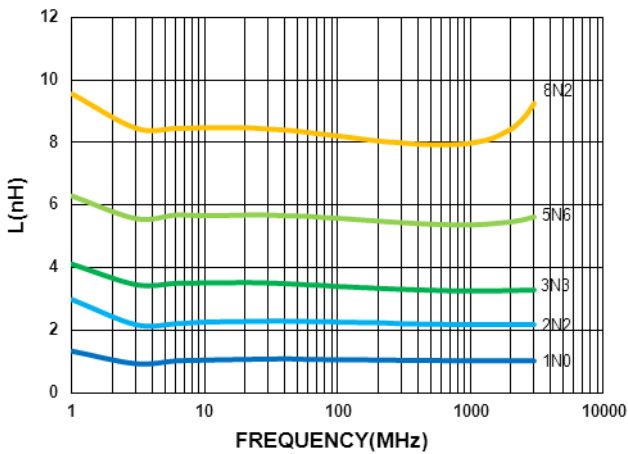

Typical **Q** vs. **Frequency**

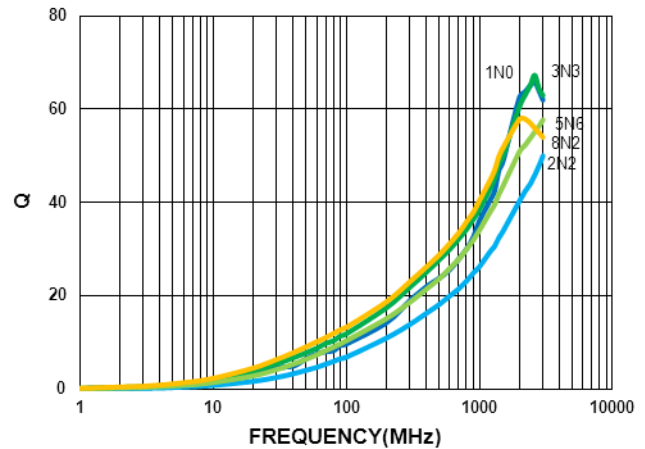

# SMD Wire Wound Ceramic Chip Inductors - BWCM Series

## Electrical Characteristics

Part Number	Inductance (nH)	Tolerance (±%)	Test Frequency (MHz)	Q Typ.	Test Frequency (MHz)	SRF (GHz) Min	RDC (Ω) Max	Irms (mA) Typ.
BWCM001107051N5□H8	1.5	±0.2nH/±0.5nH	100	20	250	18	0.028	2100
BWCM001107052N5□H8	2.5	±0.1nH/±0.2nH/±0.5nH/2	100	30	250	15.5	0.03	2100
BWCM001107052N7□H8	2.7	±0.1nH/±0.2nH/±0.5nH/2	100	28	250	14	0.047	1500
BWCM001107053N0□H8	3.0	±0.1nH/±0.2nH/±0.5nH/2	100	20	250	12.5	0.063	1350
BWCM001107053N8□H8	3.8	±0.1nH/±0.2nH/±0.5nH/2	100	35	250	10	0.03	1950
BWCM001107053N9□H8	3.9	±0.1nH/±0.2nH/±0.5nH/2	100	35	250	10	0.03	1950
BWCM001107054N0□H8	4.0	±0.1nH/±0.2nH/±0.5nH/2	100	30	250	10	0.03	1950
BWCM001107054N1□H8	4.1	±0.1nH/±0.2nH/±0.5nH/2	100	30	250	9.6	0.044	1800
BWCM001107054N3□H8	4.3	±0.1nH/±0.2nH/±0.5nH/2	100	32	250	9.6	0.044	1800
BWCM001107054N7□H8	4.7	±0.1nH/±0.2nH/±0.5nH/2	100	31	250	8	0.071	1200
BWCM001107055N8□H8	5.8	±0.1nH/±0.2nH/±0.5nH/2	100	30	250	8	0.04	1770
BWCM001107056N2□H8	6.2	±0.1nH/±0.2nH/±0.5nH/2	100	33	250	8	0.056	1600
BWCM001107056N8□H8	6.8	2 / 5	100	30	250	7	0.068	1450
BWCM001107057N1□H8	7.1	2 / 5	100	32	250	7	0.069	1420
BWCM001107057N8□H8	7.8	2 / 5	100	30	250	7	0.05	1700
BWCM001107057N9□H8	7.9	2 / 5	100	30	250	7	0.05	1700
BWCM001107058N0□H8	8.0	2 / 5	100	30	250	7	0.05	1700
BWCM001107058N2□H8	8.2	2 / 5	100	32	250	6.5	0.069	1500
BWCM001107058N6□H8	8.6	2 / 5	100	31	250	6.5	0.07	1420
BWCM001107058N7□H8	8.7	2 / 5	100	31	250	6.5	0.07	1420
BWCM001107058N8□H8	8.8	2 / 5	100	31	250	6.5	0.07	1420
BWCM001107058N9□H8	8.9	2 / 5	100	31	250	6.5	0.07	1420
BWCM001107059N0□H8	9	2 / 5	100	30	250	6.5	0.07	1420
BWCM001107059N1□H8	9.1	2 / 5	100	32	250	6.5	0.08	1400
BWCM0011070511N□H8	11	2 / 5	100	32	250	6.2	0.083	1400
BWCM0011070515N□H8	15	2 / 5	100	31	250	5.5	0.114	1150
BWCM0011070518N□H8	18	2 / 5	100	30	250	5.2	0.13	1050
BWCM0011070519N□H8	19	2 / 5	100	30	250	5	0.156	920
BWCM0011070520N□H8	20	2 / 5	100	30	250	4.5	0.186	800
BWCM0011070523N□H8	23	2 / 5	100	29	250	4.5	0.201	760
BWCM0011070524N□H8	24	2 / 5	100	31	250	4	0.212	770
BWCM0011070527N□H8	27	2 / 5	100	30	250	4	0.288	680

**Note: When ordering, please specify tolerance code. Tolerance : B=±0.1nH , C=±0.2nH , D=±0.5nH , G=±2% , J=±5%**

- Operating temperature range - 40°C ~ 125°C(Including self - temperature rise)
- Irms for a 15°C temperature rise from 25°C ambient with current
- Offset value : -0.556nH
- Measure Equipment :  
 L & Q : Agilent E4991A+Agilent HP16197A  
 SRF : Agilent HP8753D/Agilent HP8722ES  
 RDC : Chroma 16502  
 Irms : HP4284A+HP42841A/HP4285A+HP42841A

Please be sure to request approval specifications that provide further details of the products. Kindly note that the content of these specifications are subject to change or may be discontinued without prior notice. This product may not be designed/used in medical or high risk applications without Chilisin approval. Please contact our sales department before ordering.

# SMD Wire Wound Ceramic Chip Inductors - BWCM Series

Part Number	Inductance (nH)	Tolerance (±%)	Test Frequency (MHz)	Q Typ.	Test Frequency (MHz)	SRF (GHz) Min	RDC (Ω) Max	I <sub>rms</sub> (mA) Typ.
BWCM0011070533N□H8	33	2 / 5	100	30	250	3.6	0.336	620
BWCM0011070539N□H8	39	2 / 5	100	28	250	3.4	0.456	530
BWCM0011070547N□H8	47	2 / 5	100	25	200	3.2	0.648	440
BWCM0011070551N□H8	51	2 / 5	100	25	200	2.9	0.696	415
BWCM0011070553N□H8	53	2 / 5	100	25	200	2.9	0.696	415
BWCM0011070556N□H8	56	2 / 5	100	25	200	2.9	0.996	340
BWCM0011070568N□H8	68	2 / 5	100	25	200	2.5	1.128	320
BWCM0011070575N□H8	75	2 / 5	100	25	200	2.4	1.224	320

**Note:** When ordering, please specify tolerance code. Tolerance : B=±0.1nH , C=±0.2nH , D=±0.5nH , G=±2% , J=±5%

- Operating temperature range - 40°C ~ 125°C(Including self - temperature rise)
- I<sub>rms</sub> for a 15°C temperature rise from 25°C ambient with current
- Offset value : -0.556nH
- Measure Equipment :  
 L & Q : Agilent E4991A+Agilent HP16197A  
 SRF : Agilent HP8753D/Agilent HP8722ES  
 RDC : Chroma 16502  
 I<sub>rms</sub> : HP4284A+HP42841A/HP4285A+HP42841A

Typical **L** vs. **F**requency

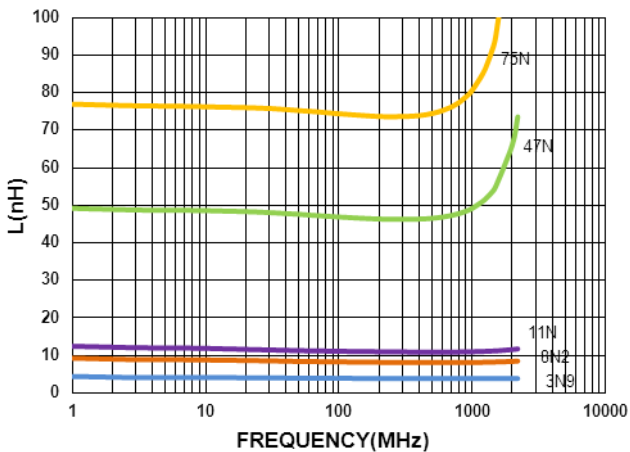

Typical **Q** vs. **F**requency

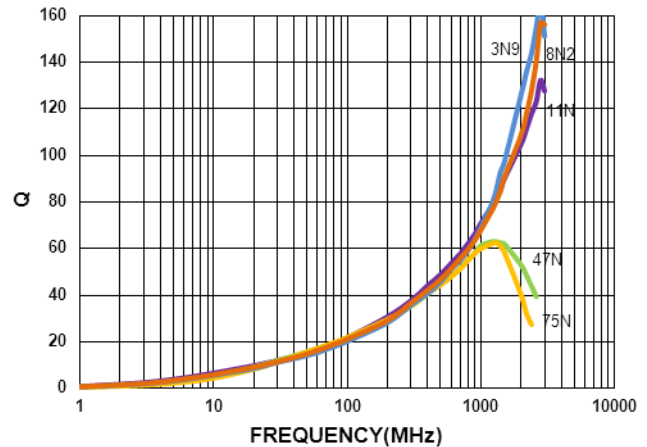

# SMD Wire Wound Ceramic Chip Inductors - BWCM Series

## Electrical Characteristics

Part Number	Inductance (nH)	Tolerance (±%)	Test Frequency (MHz)	Q Typ.	Test Frequency (MHz)	SRF (GHz) Min	RDC (Ω) Max	Irms (mA) Typ.
BWCM001107052N2□L8	2.2	±0.1nH/±0.2nH/±0.5nH/2	100	30	250	15.5	0.022	2530
BWCM001107052N4□L8	2.4	±0.1nH/±0.2nH/±0.5nH/2	100	30	250	15.5	0.022	2530
BWCM001107053N3□L8	3.3	±0.1nH/±0.2nH/±0.5nH/2	100	30	250	14	0.03	2000
BWCM001107053N4□L8	3.4	±0.1nH/±0.2nH/±0.5nH/2	100	30	250	10	0.03	1950
BWCM001107053N5□L8	3.5	±0.1nH/±0.2nH/±0.5nH/2	100	30	250	10	0.03	1950
BWCM001107053N6□L8	3.6	±0.1nH/±0.2nH/±0.5nH/2	100	30	250	10	0.03	1950
BWCM001107055N0□L8	5	±0.1nH/±0.2nH/±0.5nH/2	100	32	250	10	0.04	1770
BWCM001107055N1□L8	5.1	±0.1nH/±0.2nH/±0.5nH/2	100	35	250	8	0.04	1770
BWCM001107055N2□L8	5.2	±0.1nH/±0.2nH/±0.5nH/2	100	35	250	8	0.04	1770
BWCM001107055N3□L8	5.3	±0.1nH/±0.2nH/±0.5nH/2	100	35	250	8	0.04	1770
BWCM001107055N4□L8	5.4	±0.1nH/±0.2nH/±0.5nH/2	100	35	250	8	0.04	1770
BWCM001107055N5□L8	5.5	±0.1nH/±0.2nH/±0.5nH/2	100	35	250	8	0.04	1770
BWCM001107055N6□L8	5.6	±0.1nH/±0.2nH/±0.5nH/2	100	35	250	8	0.04	1770
BWCM001107055N7□L8	5.7	±0.1nH/±0.2nH/±0.5nH/2	100	30	250	8	0.04	1770
BWCM001107057N2□L8	7.2	2 / 5	100	32	250	7	0.05	1700
BWCM001107057N3□L8	7.3	2 / 5	100	32	250	7	0.05	1700
BWCM001107057N4□L8	7.4	2 / 5	100	30	250	7	0.05	1700
BWCM001107057N5□L8	7.5	2 / 5	100	35	250	7	0.05	1700
BWCM001107057N6□L8	7.6	2 / 5	100	30	250	7	0.05	1700
BWCM001107057N7□L8	7.7	2 / 5	100	30	250	7	0.05	1700
BWCM001107059N2□L8	9.2	2 / 5	100	32	250	6	0.081	1400
BWCM001107059N3□L8	9.3	2 / 5	100	34	250	6	0.081	1400
BWCM001107059N4□L8	9.4	2 / 5	100	33	250	6	0.081	1400
BWCM001107059N5□L8	9.5	2 / 5	100	32	250	6	0.081	1400
BWCM001107059N6□L8	9.6	2 / 5	100	33	250	6	0.081	1400
BWCM001107059N7□L8	9.7	2 / 5	100	33	250	6	0.081	1400
BWCM001107059N8□L8	9.8	2 / 5	100	34	250	6	0.081	1400
BWCM001107059N9□L8	9.9	2 / 5	100	32	250	6	0.081	1400
BWCM0011070510N□L8	10	2 / 5	100	31	250	6	0.081	1400
BWCM0011070512N□L8	12	2 / 5	100	30	250	5.2	0.093	1240

**Note: When ordering, please specify tolerance code. Tolerance : B=±0.1nH , C=±0.2nH , D=±0.5nH , G=±2% , J=±5%**

- Operating temperature range - 40°C ~ 125°C(Including self - temperature rise)
- Irms for a 15°C temperature rise from 25°C ambient with current
- Offset value : -0.556nH
- Measure Equipment :  
L & Q : Agilent E4991A+Agilent HP16197A  
SRF : Agilent HP8753D/Agilent HP8722ES  
RDC : Chroma 16502  
Irms : HP4284A+HP42841A/HP4285A+HP42841A

# SMD Wire Wound Ceramic Chip Inductors - BWCM Series

Part Number	Inductance (nH)	Tolerance (±%)	Test Frequency (MHz)	Q Typ.	Test Frequency (MHz)	SRF (GHz) Min	RDC (Ω) Max	I <sub>rms</sub> (mA) Typ.
BWCM0011070513N□L8	13	2 / 5	100	30	250	5.2	0.093	1240
BWCM0011070516N□L8	16	2 / 5	100	31	250	5	0.126	1000
BWCM0011070522N□L8	22	2 / 5	100	30	250	4.5	0.202	780
BWCM0011070530N□L8	30	2 / 5	100	30	250	3.8	0.309	660
BWCM0011070536N□L8	36	2 / 5	100	30	250	3.5	0.431	540
BWCM0011070543N□L8	43	2 / 5	100	30	250	3.4	0.516	515

**Note:** When ordering, please specify tolerance code. Tolerance : B=±0.1nH , C=±0.2nH , D=±0.5nH , G=±2% , J=±5%

- Operating temperature range - 40°C ~ 125°C(Including self - temperature rise)
- I<sub>rms</sub> for a 15°C temperature rise from 25°C ambient with current
- Offset value : -0.556nH
- Measure Equipment :  
 L & Q : Agilent E4991A+Agilent HP16197A  
 SRF : Agilent HP8753D/Agilent HP8722ES  
 RDC : Chroma 16502  
 I<sub>rms</sub> : HP4284A+HP42841A/HP4285A+HP42841A

Typical L vs. Frequency

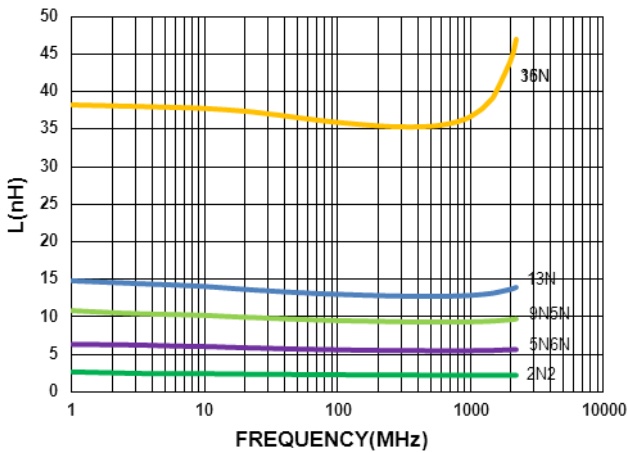

Typical Q vs. Frequency

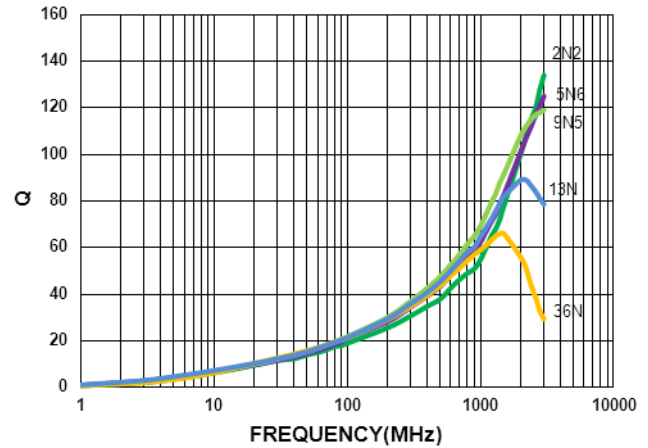



# SMD Wire Wound Ceramic Chip Inductors - BWCM Series

## Electrical Characteristics

Part Number	Inductance (nH)	Tolerance (±%)	Test Frequency (MHz)	Q Min	Test Frequency (MHz)	SRF (GHz) Min	RDC (Ω) Max	Irms (mA) Max
BWCM001207071N5□00	1.5	±0.1nH/±0.2nH/±0.5nH	100	10	250	18.0	0.03	1000
BWCM001207072N4□00	2.4	±0.1nH/±0.2nH/±0.5nH	100	20	250	15.0	0.05	850
BWCM001207072N5□00	2.5	±0.1nH/±0.2nH/±0.5nH	100	20	250	15.0	0.05	850
BWCM001207072N7□00	2.7	±0.1nH/±0.2nH/±0.5nH	100	20	250	15.0	0.05	850
BWCM001207072N9□00	2.9	±0.1nH/±0.2nH/±0.5nH	100	20	250	15.0	0.07	750
BWCM001207073N9□00	3.9	3 / 5	100	25	250	10.0	0.07	750
BWCM001207074N1□00	4.1	3 / 5	100	25	250	10.0	0.07	750
BWCM001207074N3□00	4.3	3 / 5	100	25	250	10.0	0.07	750
BWCM001207074N7□00	4.7	3 / 5	100	25	250	8.0	0.07	750
BWCM001207075N1□00	5.1	3 / 5	100	25 typ	250	8.0	0.12	600
BWCM001207075N8□00	5.8	3 / 5	100	25	250	8.0	0.12	700
BWCM001207076N2□00	6.2	3 / 5	100	25	250	8.0	0.09	700
BWCM001207076N8□00	6.8	3 / 5	100	25	250	6.0	0.09	700
BWCM001207077N3□00	7.3	3 / 5	100	25	250	6.0	0.13	570
BWCM001207077N5□00	7.5	3 / 5	100	25	250	6.0	0.13	570
BWCM001207078N2□00	8.2	3 / 5	100	25	250	5.5	0.14	540
BWCM001207078N7□00	8.7	3 / 5	100	25	250	5.5	0.14	540
BWCM001207079N1□00	9.1	3 / 5	100	25	250	5.5	0.14	540
BWCM001207079N5□00	9.5	3 / 5	100	25	250	5.5	0.14	540
BWCM0012070710N□00	10	2 / 3 / 5	100	25	250	5.5	0.17	500
BWCM0012070711N□00	11	2 / 3 / 5	100	30	250	5.5	0.14	500
BWCM0012070712N□00	12	2 / 3 / 5	100	30	250	5.5	0.14	500
BWCM0012070713N□00	13	2 / 3 / 5	100	25	250	5.0	0.21	430
BWCM0012070715N□00	15	2 / 3 / 5	100	30	250	5.0	0.16	460
BWCM0012070716N□00	16	2 / 3 / 5	100	25	250	4.5	0.24	370
BWCM0012070718N□00	18	2 / 3 / 5	100	25	250	4.5	0.27	370
BWCM0012070719N□00	19	2 / 3 / 5	100	25	250	4.5	0.27	370
BWCM0012070720N□00	20	2 / 3 / 5	100	25	250	4.0	0.27	370
BWCM0012070722N□00	22	2 / 3 / 5	100	25	250	4.0	0.30	310
BWCM0012070723N□00	23	2 / 3 / 5	100	25	250	3.8	0.30	310
BWCM0012070724N□00	24	2 / 3 / 5	100	25	250	3.5	0.52	280
BWCM0012070727N□00	27	2 / 3 / 5	100	25	250	3.5	0.52	280

**Note: When ordering, please specify tolerance code. Tolerance : B=±0.1nH , C=±0.2nH , D=±0.5nH , G=±2% , H=±3% , J=±5%**

- Operating temperature range - 40°C ~ 125°C(Including self - temperature rise)
- Irms for a 15°C temperature rise from 25°C ambient with current
- Measure Equipment :  
 L & Q : Agilent E4991A+Agilent HP16197A  
 SRF : Agilent HP8753D/Agilent HP8722ES  
 RDC : Chroma 16502  
 Irms : HP4284A+HP42841A/HP4285A+HP42841A

# SMD Wire Wound Ceramic Chip Inductors - BWCM Series

## Electrical Characteristics

Part Number	Inductance (nH)	Tolerance (±%)	Test Frequency (MHz)	Q Min	Test Frequency (MHz)	SRF (GHz) Min	RDC (Ω) Max	Irms (mA) Max
BWCM0012070730N□00	30	2 / 3 / 5	100	25	250	3.3	0.58	270
BWCM0012070733N□00	33	2 / 3 / 5	100	25	250	3.2	0.63	260
BWCM0012070736N□00	36	2 / 3 / 5	100	25	250	3.1	0.63	260
BWCM0012070739N□00	39	2 / 3 / 5	100	25	250	3.0	0.70	250
BWCM0012070740N□00	40	2 / 3 / 5	100	25	250	3.0	0.70	250
BWCM0012070747N□00	47	2 / 3 / 5	100	25	200	2.9	1.08	210
BWCM0012070751N□00	51	2 / 3 / 5	100	25	200	2.85	1.08	210
BWCM0012070756N□00	56	2 / 3 / 5	100	25	200	2.80	1.17	200
BWCM0012070762N□00	62	2 / 3 / 5	100	20	200	2.60	1.82	145
BWCM0012070768N□00	68	2 / 3 / 5	100	20	200	2.50	1.96	140
BWCM0012070772N□00	72	2 / 3 / 5	100	20	150	2.50	2.10	135
BWCM0012070775N□00	75	2 / 3 / 5	100	20	150	2.40	2.10	135
BWCM0012070782N□00	82	2 / 3 / 5	100	20	150	2.30	2.24	130
BWCM0012070791N□00	91	2 / 3 / 5	100	20	150	2.10	2.38	125
BWCM00120707R10□00	100	2 / 3 / 5	100	20	150	1.50	2.52	120
BWCM00120707R12□00	120	2 / 3 / 5	100	20	150	1.00	2.66	110

**Note:** When ordering, please specify tolerance code. Tolerance : B=±0.1nH , C=±0.2nH , D=±0.5nH , G=±2% , H=±3% , J=±5%

- Operating temperature range - 40°C ~ 125°C(Including self - temperature rise)
- Irms for a 15°C temperature rise from 25°C ambient with current
- Measure Equipment :  
 L & Q : Agilent E4991A+Agilent HP16197A  
 SRF : Agilent HP8753D/Agilent HP8722ES  
 RDC : Chroma 16502  
 Irms : HP4284A+HP42841A/HP4285A+HP42841A

Typical L vs. Frequency

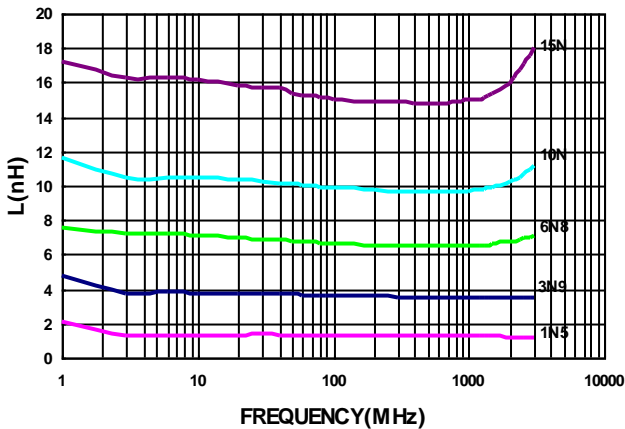

Typical Q vs. Frequency

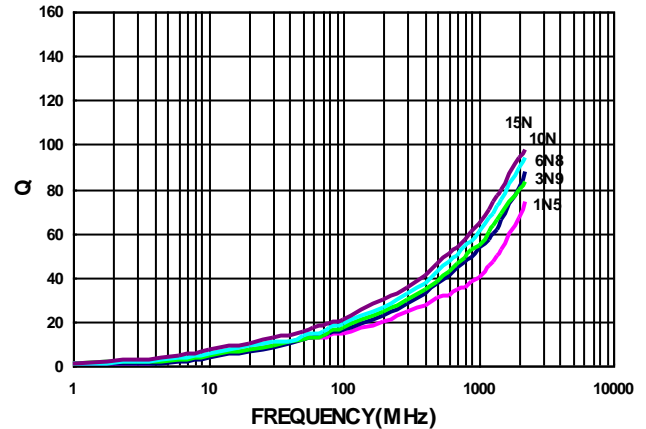

# SMD Wire Wound Ceramic Chip Inductors - BWCM Series

## Electrical Characteristics

Part Number	Inductance (nH)	Tolerance (±%)	Test Frequency (MHz)	Q Min	Test Frequency (MHz)	SRF (GHz) Min	RDC (Ω) Max	Irms (mA) Max
BWCM001610082N2□00	2.2	±0.1nH/±0.2nH/±0.5nH	100	16	250	6.0	0.049	700
BWCM001610083N6□00	3.6	3 / 5	100	25	250	6.0	0.059	850
BWCM001610083N9□00	3.9	3 / 5	100	35	250	6.0	0.059	850
BWCM001610084N3□00	4.3	3 / 5	100	35	250	6.0	0.059	850
BWCM001610084N7□00	4.7	3 / 5	100	35	250	6.0	0.059	850
BWCM001610085N6□00	5.6	3 / 5	100	35	250	6.0	0.082	750
BWCM001610086N2□00	6.2	3 / 5	100	35	250	6.0	0.082	750
BWCM001610086N8□00	6.8	3 / 5	100	35	250	6.0	0.082	750
BWCM001610087N5□00	7.5	3 / 5	100	35	250	6.0	0.082	750
BWCM001610088N2□00	8.2	3 / 5	100	35	250	6.0	0.110	650
BWCM001610088N7□00	8.7	3 / 5	100	35	250	6.0	0.110	650
BWCM001610089N1□00	9.1	3 / 5	100	35	250	6.0	0.110	650
BWCM001610089N5□00	9.5	3 / 5	100	35	250	6.0	0.110	650
BWCM0016100810N□00	10	2 / 3 / 5	100	35	250	6.0	0.110	650
BWCM0016100811N□00	11	2 / 3 / 5	100	35	250	6.0	0.110	650
BWCM0016100812N□00	12	2 / 3 / 5	100	35	250	6.0	0.130	600
BWCM0016100813N□00	13	2 / 3 / 5	100	35	250	6.0	0.130	600
BWCM0016100815N□00	15	2 / 3 / 5	100	40	250	6.0	0.130	600
BWCM0016100816N□00	16	2 / 3 / 5	100	40	250	5.5	0.160	550
BWCM0016100818N□00	18	2 / 3 / 5	100	40	250	5.5	0.160	550
BWCM0016100820N□00	20	2 / 3 / 5	100	40	250	4.9	0.160	550
BWCM0016100822N□00	22	2 / 3 / 5	100	40	250	4.6	0.170	500
BWCM0016100824N□00	24	2 / 3 / 5	100	40	250	3.8	0.210	500
BWCM0016100827N□00	27	2 / 3 / 5	100	40	250	3.7	0.210	440
BWCM0016100830N□00	30	2 / 3 / 5	100	40	250	3.3	0.230	420
BWCM0016100833N□00	33	2 / 3 / 5	100	40	250	3.2	0.230	420
BWCM0016100836N□00	36	2 / 3 / 5	100	40	250	2.9	0.260	400
BWCM0016100839N□00	39	2 / 3 / 5	100	40	250	2.8	0.260	400
BWCM0016100843N□00	43	2 / 3 / 5	100	40	200	2.7	0.290	380
BWCM0016100847N□00	47	2 / 3 / 5	100	38	200	2.6	0.290	380
BWCM0016100851N□00	51	2 / 3 / 5	100	38	200	2.5	0.330	370
BWCM0016100856N□00	56	2 / 3 / 5	100	38	200	2.4	0.350	360

**Note: When ordering, please specify tolerance code. Tolerance : B=±0.1nH , C=±0.2nH , D=±0.5nH , G=±2% , H=±3% , J=±5%**

- Operating temperature range - 40°C ~ 125°C(Including self - temperature rise)
- Irms for a 15°C temperature rise from 25°C ambient with current
- Measure Equipment :  
 L & Q : Agilent E4991A+Agilent HP16197A  
 SRF : Agilent HP8753D/Agilent HP8722ES  
 RDC : Chroma 16502  
 Irms : HP4284A+HP42841A/HP4285A+HP42841A

# SMD Wire Wound Ceramic Chip Inductors - BWCM Series

## Electrical Characteristics

Part Number	Inductance (nH)	Tolerance (±%)	Test Frequency (MHz)	Q Min	Test Frequency (MHz)	SRF (GHz) Min	RDC (Ω) Max	Irms (mA) Max
BWCM0016100862N□00	62	2 / 3 / 5	100	38	200	2.3	0.510	280
BWCM0016100868N□00	68	2 / 3 / 5	100	38	200	2.2	0.380	340
BWCM0016100872N□00	72	2 / 3 / 5	100	34	150	2.1	0.560	270
BWCM0016100875N□00	75	2 / 3 / 5	100	34	150	2.05	0.560	270
BWCM0016100882N□00	82	2 / 3 / 5	100	34	150	2.00	0.600	250
BWCM0016100891N□00	91	2 / 3 / 5	100	34	150	1.90	0.640	230
BWCM00161008R10□00	100	2 / 3 / 5	100	34	150	1.80	0.680	220
BWCM00161008R11□00	110	2 / 3 / 5	100	32	150	1.70	1.200	200
BWCM00161008R12□00	120	2 / 3 / 5	100	32	150	1.60	1.300	180
BWCM00161008R13□00	130	2 / 3 / 5	100	32	150	1.45	1.400	170
BWCM00161008R15□00	150	2 / 3 / 5	100	32	150	1.40	1.500	160
BWCM00161008R16□00	160	2 / 3 / 5	100	32	150	1.35	2.100	150
BWCM00161008R18□00	180	2 / 3 / 5	100	25	100	1.30	2.200	140
BWCM00161008R20□00	200	2 / 3 / 5	100	25	100	1.25	2.400	120
BWCM00161008R22□00	220	2 / 3 / 5	100	25	100	1.20	2.500	120
BWCM00161008R27□00	270	2 / 3 / 5	100	30	100	0.96	3.400	110
BWCM00161008R33□00	330	2 / 3 / 5	100	30	100	0.80	5.500	85
BWCM00161008R39□00	390	2 / 3 / 5	100	30	100	0.80	6.200	80
BWCM00161008R47□00	470	2 / 3 / 5	100	30	100	0.70	7.000	75

**Note:** When ordering, please specify tolerance code. Tolerance : B=±0.1nH , C=±0.2nH , D=±0.5nH , G=±2% , H=±3% , J=±5%

- Operating temperature range - 40°C ~ 125°C(Including self - temperature rise)
- I rms for a 15°C temperature rise from 25°C ambient with current
- Measure Equipment :  
 L & Q : Agilent E4991A+Agilent HP16197A  
 SRF : Agilent HP8753D/Agilent HP8722ES  
 RDC : Chroma 16502  
 I rms : HP4284A+HP42841A/HP4285A+HP42841A

Typical L vs. Frequency

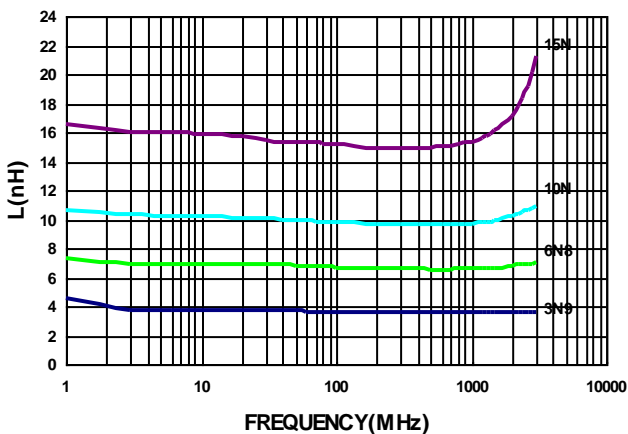

Typical Q vs. Frequency

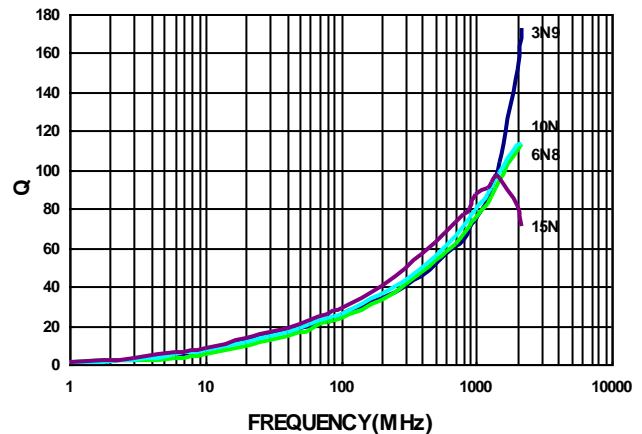

Please be sure to request approval specifications that provide further details of the products. Kindly note that the content of these specifications are subject to change or may be discontinued without prior notice. This product may not be designed/used in medical or high risk applications without Chilisin approval. Please contact our sales department before ordering.

# SMD Wire Wound Ceramic Chip Inductors - BWCM Series

## Electrical Characteristics

Part Number	Inductance (nH)	Tolerance (±%)	Test Frequency (MHz)	Q Min	Test Frequency (MHz)	SRF (GHz) Min	RDC (Ω) Max	Irms (mA) Typ.
BWCM00181010R10□H8	100	2 / 5	100	34	150	1.75	0.63	490
BWCM00181010R11□H8	110	2 / 5	100	32	150	1.73	0.7	450
BWCM00181010R12□H8	120	2 / 5	100	32	150	1.65	0.72	450
BWCM00181010R15□H8	150	2 / 5	100	28	150	1.58	0.87	420
BWCM00181010R18□H8	180	2 / 5	100	25	100	1.38	1.65	310
BWCM00181010R20□H8	200	2 / 5	100	25	100	1.35	1.74	290
BWCM00181010R21□H8	210	2 / 5	100	27	100	1.33	1.98	280
BWCM00181010R22□H8	220	2 / 5	100	25	100	1.33	2.08	280
BWCM00181010R25□H8	250	2 / 5	100	24	100	1.33	2.28	250
BWCM00181010R27□H8	270	2 / 5	100	24	100	1.25	2.42	260
BWCM00181010R30□H8	300	2 / 5	100	25	100	1.2	3.12	220
BWCM00181010R33□H8	330	2 / 5	100	25	100	1.1	3.84	190
BWCM00181010R36□H8	360	2 / 5	100	25	100	1.05	3.98	190
BWCM00181010R39□H8	390	2 / 5	100	25	100	1	4.23	190

**Note:** When ordering, please specify tolerance code. Tolerance : G=±2% , J=±5%

- Operating temperature range - 40°C ~ 125°C(Including self - temperature rise)
- I rms for a 15°C temperature rise from 25°C ambient with current
- Offset value : -0.771nH
- Measure Equipment :  
 L & Q : Agilent E4991A+Agilent HP16197A  
 SRF : Agilent HP8753D/Agilent HP8722ES  
 RDC : Chroma 16502  
 I rms : HP4284A+HP42841A/HP4285A+HP42841A

Typical **L** vs. Frequency

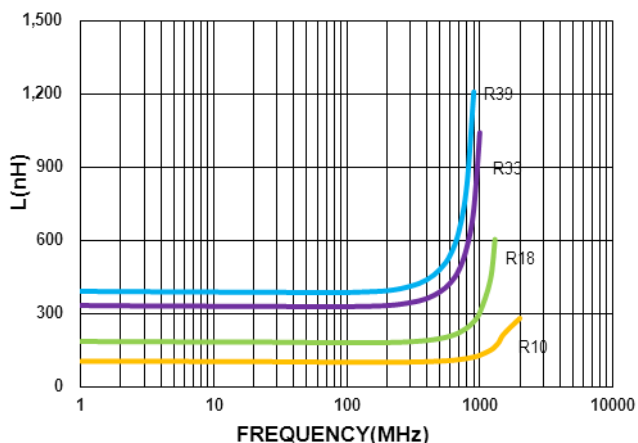

Typical **Q** vs. Frequency

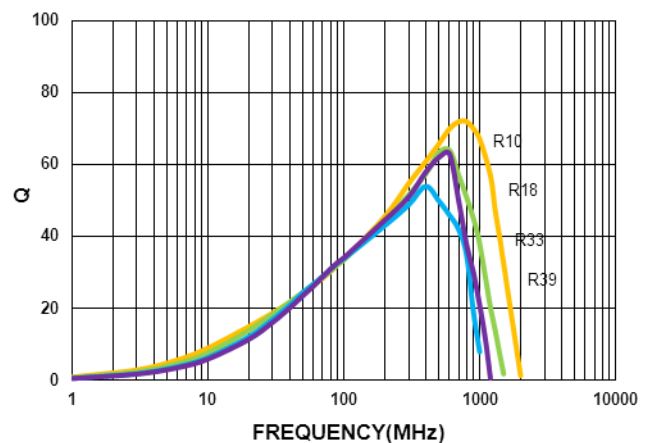

# SMD Wire Wound Ceramic Chip Inductors - BWCM Series

## Electrical Characteristics

Part Number	Inductance (nH)	Tolerance (±%)	Test Frequency (MHz)	Q Min	Test Frequency (MHz)	SRF (GHz) Min	RDC (Ω) Max	Irms (mA) Typ.
BWCM001810102N2□L8	2.2	±0.2nH	100	24	250	15	0.018	3200
BWCM001810102N4□L8	2.4	±0.2nH	100	18	250	15	0.026	2400
BWCM001810103N9□L8	3.9	±0.1nH/±0.2nH/ 2	100	30	250	10	0.028	2200
BWCM001810104N3□L8	4.3	±0.1nH/±0.2nH/ 2	100	35	250	11.6	0.036	2100
BWCM001810104N7□L8	4.7	±0.1nH/±0.2nH/ 2	100	25	250	10.4	0.054	1500
BWCM001810104N9□L8	4.9	±0.1nH/±0.2nH/ 2	100	23	250	7.3	0.081	1200
BWCM001810105N6□L8	5.6	±0.2nH/ 2	100	38	250	6.65	0.04	1900
BWCM001810106N8□L8	6.8	±0.2nH/ 2	100	40	250	6.65	0.04	1900
BWCM001810107N5□L8	7.5	±0.2nH/ 2	100	35	250	7	0.048	1500
BWCM001810108N2□L8	8.2	±0.2nH/ 2	100	38	250	4.75	0.052	1600
BWCM001810108N7□L8	8.7	±0.2nH/ 2	100	38	250	4.75	0.052	1600
BWCM001810109N1□L8	9.1	±0.2nH/ 2	100	38	250	4.75	0.052	1600
BWCM001810109N5□L8	9.5	±0.2nH/ 2	100	38	250	4.75	0.052	1600
BWCM0018101010N□L8	10	2 / 5	100	38	250	4.75	0.052	1600
BWCM0018101011N□L8	11	2 / 5	100	40	250	4.75	0.052	1600
BWCM0018101012N□L8	12	2 / 5	100	37	250	5	0.064	1500
BWCM0018101013N□L8	13	2 / 5	100	37	250	5	0.064	1500
BWCM0018101015N□L8	15	2 / 5	100	38	250	4.6	0.075	1400
BWCM0018101016N□L8	16	2 / 5	100	40	250	4.6	0.075	1400
BWCM0018101018N□L8	18	2 / 5	100	40	250	4.6	0.075	1400
BWCM0018101022N□L8	22	2 / 5	100	40	250	3.45	0.086	1300
BWCM0018101023N□L8	23	2 / 5	100	40	250	3.45	0.086	1300
BWCM0018101024N□L8	24	2 / 5	100	40	250	3.45	0.086	1300
BWCM0018101027N□L8	27	2 / 5	100	40	250	3.6	0.098	1200
BWCM0018101028N□L8	28	2 / 5	100	40	250	3.6	0.098	1200
BWCM0018101030N□L8	30	2 / 5	100	40	250	2.88	0.12	1100
BWCM0018101033N□L8	33	2 / 5	100	40	250	3.15	0.11	1100
BWCM0018101036N□L8	36	2 / 5	100	37	250	3	0.2	910
BWCM0018101039N□L8	39	2 / 5	100	40	250	3.28	0.16	1000
BWCM0018101043N□L8	43	2 / 5	100	40	250	2.78	0.21	840
BWCM0018101047N□L8	47	2 / 5	100	32	200	2.7	0.23	830
BWCM0018101051N□L8	51	2 / 5	100	32	200	2.7	0.23	830
BWCM0018101056N□L8	56	2 / 5	100	38	200	2.6	0.26	770

**Note: When ordering, please specify tolerance code. Tolerance : B=±0.1nH , C=±0.2nH , G=±2% , J=±5%**

- Operating temperature range - 40°C ~ 125°C(Including self - temperature rise)
- Irms for a 15°C temperature rise from 25°C ambient with current
- Offset value : -0.771nH
- Measure Equipment :  
L & Q : Agilent E4991A+Agilent HP16197A  
SRF : Agilent HP8753D/Agilent HP8722ES  
RDC : Chroma 16502

Please be sure to request approval specifications that provide further details of the products. Kindly note that the content of these specifications are subject to change or may be discontinued without prior notice. This product may not be designed/used in medical or high risk applications without Chilisin approval. Please contact our sales department before ordering.

# SMD Wire Wound Ceramic Chip Inductors - BWCM Series

Part Number	Inductance (nH)	Tolerance (±%)	Test Frequency (MHz)	Q Min	Test Frequency (MHz)	SRF (GHz) Min	RDC (Ω) Max	Irms (mA) Typ.
BWCM0018101068N□L8	68	2 / 5	100	37	200	2.38	0.38	630
BWCM0018101072N□L8	72	2 / 5	100	34	150	2.33	0.47	560
BWCM0018101075N□L8	75	2 / 5	100	28	150	2.28	0.41	590
BWCM0018101082N□L8	82	2 / 5	100	34	150	2.23	0.5	550
BWCM0018101091N□L8	91	2 / 5	100	33	150	1.9	0.54	520

**Note: When ordering, please specify tolerance code. Tolerance : B=±0.1nH , C=±0.2nH , G=±2% , J=±5%**

- Operating temperature range - 40°C ~ 125°C(Including self - temperature rise)
- Irms for a 15°C temperature rise from 25°C ambient with current
- Offset value : -0.771nH
- Measure Equipment :  
 L & Q : Agilent E4991A+Agilent HP16197A  
 SRF : Agilent HP8753D/Agilent HP8722ES  
 RDC : Chroma 16502  
 Irms : HP4284A+HP42841A/HP4285A+HP42841A

**Typical L vs. Frequency**

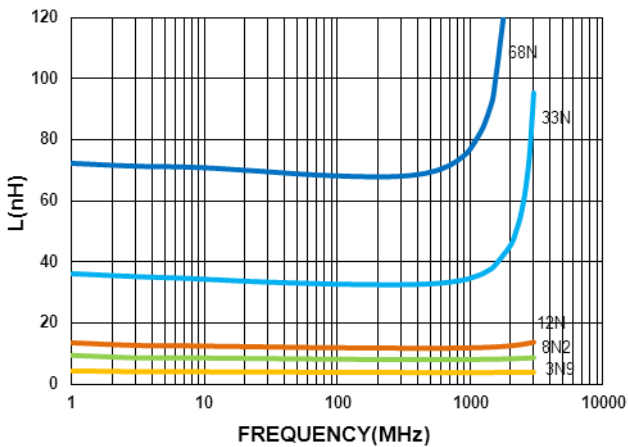

**Typical Q vs. Frequency**

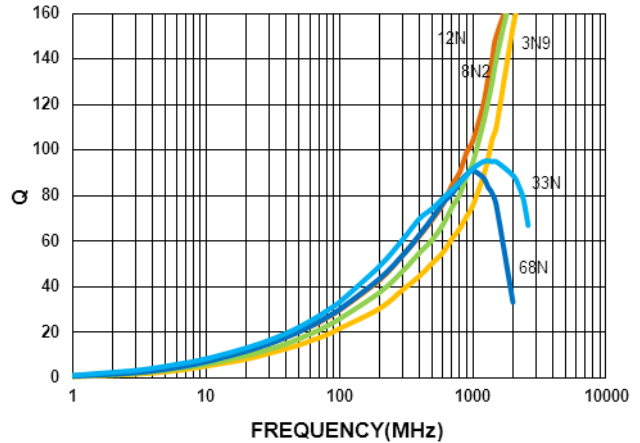

# SMD Wire Wound Ceramic Chip Inductors - BWCM Series

## Packaging Specifications

### Tape Dimensions

Figure 1

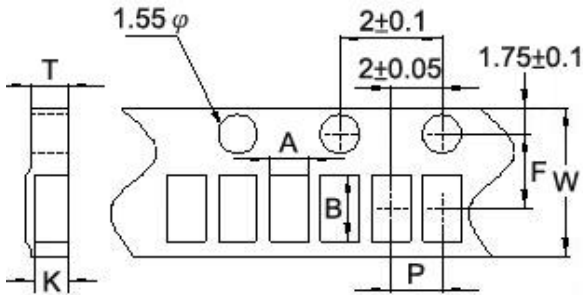

### Tape Material

Carrier Tape: Paper  
Cover Tape: Polystyrene

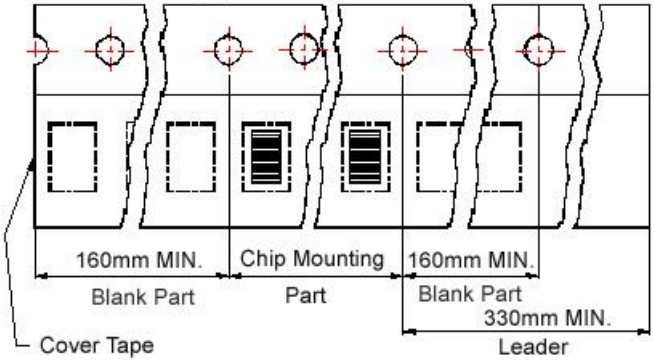
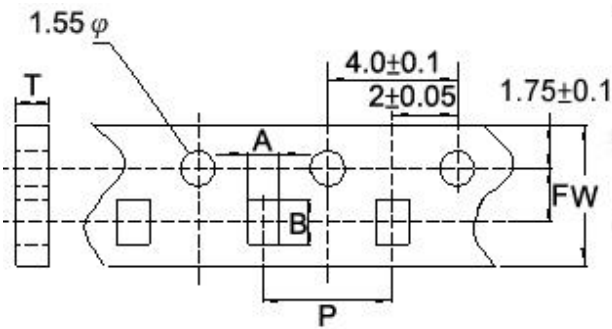
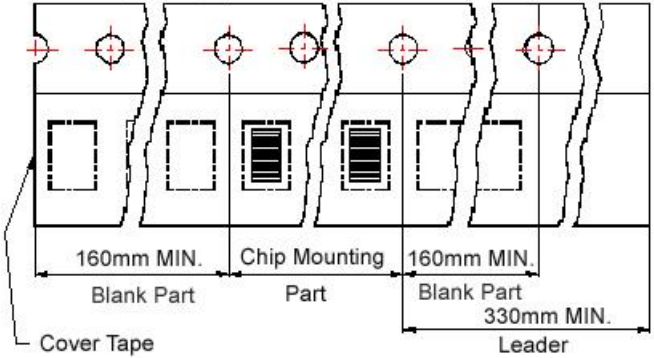

Figure 2



Carrier Tape: Paper  
Cover Tape: Polystyrene



### Reel Dimensions

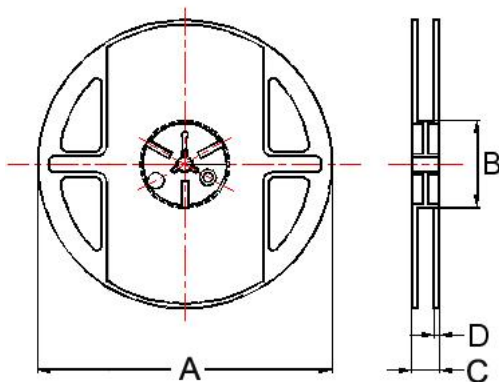

### Dimensions in mm

TYPE	Fig.	Tape Dimensions							Reel Dimensions				Quantity PCS / Reel
		A	B	T	W	P	F	K	A	B	C	D	
BWCM00060404	1	0.79	0.89	0.65	8	2	3.5	0.45	178	60	12	1.5	4000
BWCM00110705	1	0.85	1.25	0.75	8	2	3.5	0.60	178	60	12	1.5	4000
BWCM00120707	1	0.67	1.20	0.75	8	2	3.5	0.59	178	60	12	1.5	4000
BWCM00161008	2	1.20	1.80	1.05	8	4	3.5	-	178	60	12	1.5	4000
BWCM00181010	2	1.20	2.00	1.10	8	4	3.5	-	178	60	12	1.5	4000